

# himox

## Air Purifier

Model: HIMOX-H05



## User Manual

Thanks for your purchase. To provide you a better user experience, please read this manual carefully before operating or maintaining the device, and retain it for future reference.

# Contents

H05 air purifier packing list	02
Quick start use scenarios	03
How to adjust wind	03
How to use in sleep	03
Regularly shutdown	03
Safety precautions	04
Product introduction	05
Product component name	05
Operation mode and function description	06
Name and function of keys	06
Maintenance instructions	07
1. Clean surface	07
2. Remove all plastic bags of the filter	08
3. Clean or replace filter	08
Fault handling and solution	09
Cautions for power cord	10
Warranty and service	11
Order part or accessories	11
Filters	11

## H05 Air Purifier Packing List

No	Item	Model No	Unit	Qty	Remarks
1	Device		PC	1	
2	Manual		PC	1	
3	(HEPA H13) Filter		PC	1	Please remove the plastic bag before use



Please Note

H05 air purifier fit US standard, 110-120V / 60HZ, otherwise it will be damaged.

## Quick start use scenarios

### How to adjust wind

Press the "SPEED" button to adjust the wind speed.



### How to use in sleep

Keep the device in running state, then press wind speed button to turn it into sleep mode. It can work in silent under this mode. All the indicator lights are in the off state except for the sleep mode light. Also the sleep mode light will be auto-off 10s later. Press any button to exit sleep mode.



### Regularly shutdown

Keep the device in running state, then press the "Timer" button to choose auto-off time. The setup time can be 1H, 2H, 4H, 8H.



## Safety precautions

Dear customer:







Thank you for choosing Himox product. In order to help you read and use this manual properly and prevent personal injury and damage accidents, please read carefully and comply with the content of following symbols.









Any content with this sign must be absolutely prohibited, otherwise it may cause damage to the machine or endanger the personal safety of users.



Any content with this sign must be strictly operated according to the warning content. It concerns product safety and personal safety of users.

-  Do not allow paint, insecticide, alcohol or chemical to be sprayed on the surface of air purifier, or it may cause surface cracks even short circuit occurs which can lead electric shock or fire accident
-  Do not use the air purifier in the room with fumigation type pesticides. Chemical residue could be accumulated inside the machine and then release from the outlet, making harm to health. The room should keep ventilated thoroughly after you use insecticide.
-  Do not use air purifier in flammable, explosive and corrosive gas environment
-  Do not touch the air inlet and air outlet when operating, do not put the hands or any object insert the air inlet and outlet to avoid injury or damage to the air purifier.
-  Do not seat or put objects on the air purifier or it is easy to cause accidental loss or injury.
-  Do not use air purifier in humid conditions like base room, as these situations may cause current leakage which can lead electric shock or fire accident.
-  Do not alter, decompose and repair the air purifier without authorization, otherwise it may cause fire, electric shock, malfunction, etc.

-  Do not touch power plug with wet hand, or else may cause electric shock.
-  Please make sure to turn off the power before cleaning or moving air purifier.
-  When not in use for a long time, please unplug the power cord.
-  When air purifier smells bad, it should be stopped using and shut off. Contact the after-sales personnel; for inspection to avoid malfunction or fire.
-  The outlet is easy to fall into sundries. Please check before use to avoid children putting sundries in it.
-  Air purifiers should be placed at least 50 centimeters away from walls or other obstacles.
-  If the power cord is damaged, in order to avoid danger, it must be replaced by the manufacturer or its maintenance department or similar full-time personnel.

## Product introduction

### Product Component Name

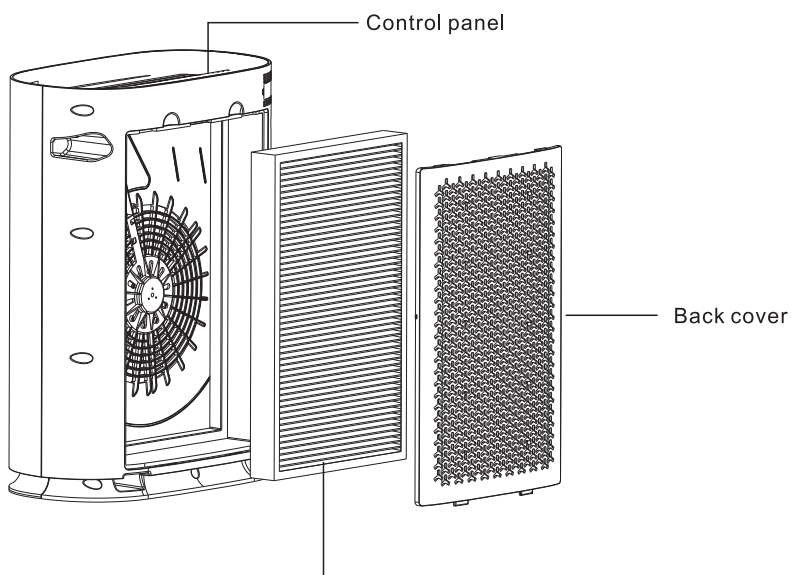
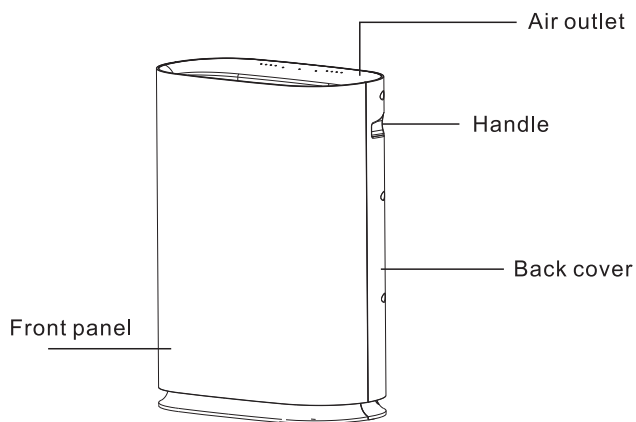



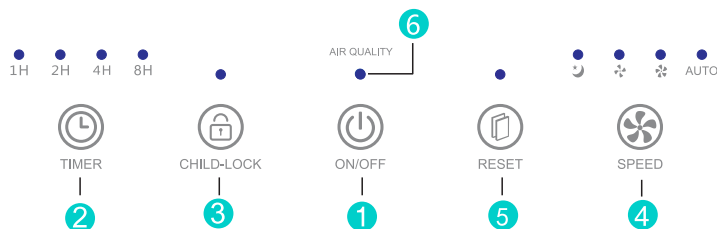

3 in 1 filter ( pre-filter + HEPA H13 filter + Active carbon filter)

# Operation mode and function description

## Name and Function of Keys



- 1**  **ON/OFF button**  
Turn on/off air purifier.
- 2**  **TIMER**  
Set an auto-off time. Press this button repeatedly to choose timer between 1-2-4-8 hours. The corresponding indicator lights in the display area will be lit up.
- 3**  **CHILD-LOCK**  
Long press this button for 3-6s, child-lock is on. It's useless to press any other button under child-lock mode. Long press this button for 3-6s again to turn off child-lock mode.
- 4**  **SPEED**  
Press this button to change wind speed between automatic, sleep, low to high cycle selection, the corresponding indicator lights in the display area will be lit up.

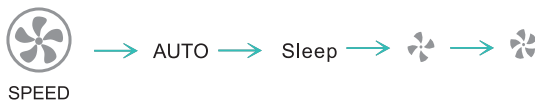

- 5**  **Filter RESET button**  
When the purifier running for 1500 hours, and the indicator light of filter RESET will be on to remind to replace the filter. After replacing the filter, long press this button for 3s till indicator light off, recovering filter service timing.
- 6** **Indicator light of air quality**  
In the auto mode, different color are displayed for different air quality. Air purifier will automatically adjust motor speed according to air quality.

Green	Excellent
Blue	Good
Red	Bad

## Maintenance instructions

- 1 Air purifiers are not allowed to be placed on soft or uneven surfaces to avoid the danger of leakage caused by vibration or noise during operation.
- 2 Do not place any thin strips or hard objects in the air purifier to avoid damage to the machine.

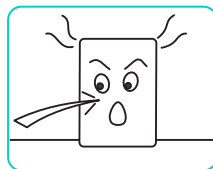
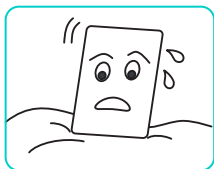

- 3 When turning off or not using for a long time, please unplug the power cord and put the machine where it is not suitable for children to touch.
- 4 In order to have a good purification effect, the machine should be kept in a wide area to avoid obstructing air circulation.

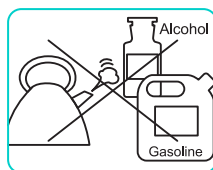
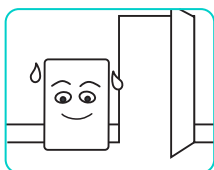

- 5 When the machine is being maintained, checked and moved, please turn it off and unplug the power cord. Otherwise, it may cause electric shock and injury.
- 6 When the composite filter is expired, you can contact the seller to purchase it.



Cut off the power supply in any of the following maintenance steps

In order to improve the service life of air purifier, please maintain the air purifier regularly. Before maintenance please turn off the air purifier and unplug the power cord. If the purifier needs to replace the filter, the indicator light of filter on the control panel will flash to remind users to replace the filter.

### 1. Clean surface

When cleaning the surface of air purifier, please cut off the power supply and clean it with soft and clean cloth. Do not clean it with alcohol, gasoline, benzene and other chemical solvents.



## 2. Remove all plastic bags of the filter

Before using the air purifier for the first time, please open the back cover of the air purifier and take out the filter, and make sure to remove the plastic bag of the filter, otherwise the product will not be able to purify the air normally.

Please keep plastic bags away from babies and toddlers so as to avoid accidents when babies and toddlers come into contact with plastic bags.

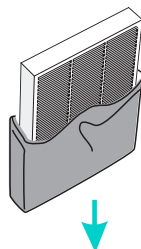

## 3. Clean or replace filter

- 1) Shown in picture A: remove filter from the air purifier
  - 2) Shown in picture B: remove PE bag of the filter
  - 3) Shown in picture C: Install new filter into air purifier and reinstall the back cover
  - 4) After replacing the filter, plug in the power plug and turn on air purifier. Press the filter reset button for 3s till the reset indicator are turning off, and the filter is reset successfully.
- ※ Special reminder: composite filter of air purifier can not be cleaned

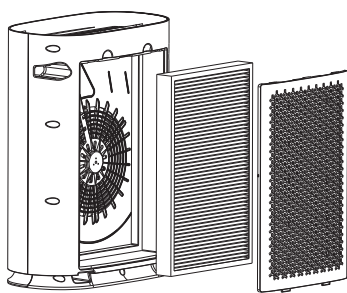

Picture A

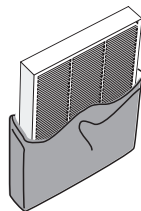

Picture B

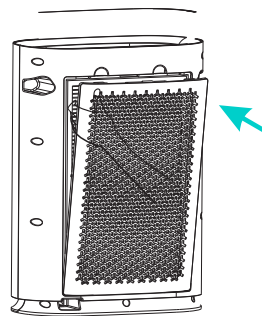

Picture C

## Fault handing and solution

Phenomena	Possible reason	Possible solution
Air purifier can not work	Power supply does not work.	Unplug the power cord and replug it
	The standard of power plug is wrong	Contact customer service center
	Back cover is installed unproperly	Re-install the back cover
The sound is dull when turn on the purifier, and air output is small	The PE bag of filter are not removed	Remove the PE bag of filter and re-install the filter in right way
	The air outlet was covered	Turn off the purifier and remove the cover from the air purifier
The air outlet has a peculiar smell	Is there a large amount of odor released continuously near the inlet	Remove the odor and make the purifier work for a period of time before the odor gradually disappears
	Whether the filter reach the service time	Replace the filter

## Cautions for power cord

### Cautions for power cord



- Do not use power sources other than rated voltage, otherwise it may cause fire, electric shock etc.
- Do not bend, pull, twist, tie the power cord arbitrarily, do not put it close to the high temperature object. Poor power cord may cause fire, electric shock etc.
- Do not make it be pressed by heavy objects or be clamped, otherwise it may cause fire, electric shock etc.
- Please do not use it when the power cord or plug is broken or the power socket is loosened, otherwise it may cause fire, electrical shock, short circuit etc.
- Do not touch power plug with wet hands, or it may cause electric shock.
- If the purifier power cord is out of order, you must entrust machine manufacturer maintenance service center or qualified technicians to replace it to keep danger way.
- Dust on power plug and socket should be cleaned regularly otherwise it may cause fire, electric shock etc.



## WARNING

Non-professional should not disassemble the purifier without authorization in order to avoid the danger of electric shock. When replacing the filter, please unplug the power cord first.

If there is a malfunction, please follow the instruction to remove. If it can not be eliminated, please contact our customer service center.

## Warranty and service

If you want to know more information or have any questions, please contact customer service center.

Product specification may be changed without prior notice.

Please refer to attached warranty card for detailed warranty terms.

## Order part or accessories

If you want to change parts or purchase additional parts, please contact customer service center.

## Filters

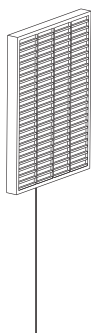

3 in 1 filter ( pre-filter + HEPA H13 filter +Active carbon filter)

### Reminder

In order to protect the environment, after the product or its components are discarded, as a consumer, you have the responsibility to separate it from domestic waste and send it to a qualified recycling site, which will be disassembled and recycled according to the relevant regulations of the state. For more information on the recycling of this product, please consult the local government, waste disposal agencies, etc.

# Himox

*Bringing healthy quality life*

Twitter : [@Himox\\_official](#)

Email: [Support@Himox.com](mailto:Support@Himox.com)

Website: [Himox.com](http://Himox.com)

Youtube: [Himox](#)

Facebook: [Himox.fans](#)

Insta: [Himox.fans](#)